



# KIKK-EL CAP CHANGER

PNEUMATIC AUTOMATIC  
CAP CHANGER SYSTEM



# STRAIGHT TIP CARTRIDGE MAGAZINE

KIKK-EL

Pneumatic System Tip Changer

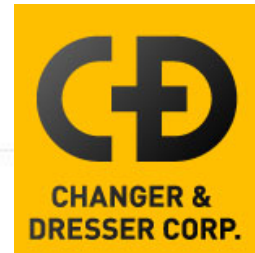
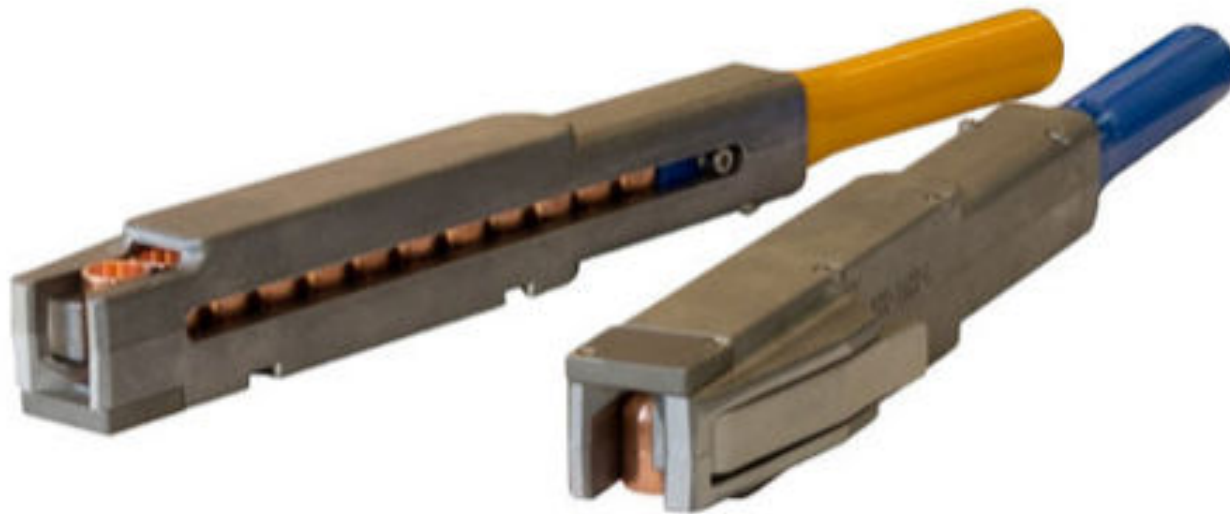

- Light Compact
- Easy to install

**RAM**  
SOLUTIONS, INC.

# Features of our KIKK-EL Cap Changer

## FEATURE

---

1. Easy teaching.
2. Correspond to  $\Phi 13, \Phi 16, \Phi 19, \Phi 20$  cap tips.
3. One touch operation cartridge.
4. Correspond to male and female tip.
5. 14pcs of  $\phi 13$  cap tips can be set in tip cartridge.
6. 12pcs of  $\phi 16$  cap tips can be set in tip cartridge.
7. 10pcs of  $\phi 19$  and  $\phi 20$  cap tips can be set in tip cartridge.
8. Detect timing of refilling cap tip by proximate sensor(Optional).
9. Detect of exchange error by limit switch(Optional).

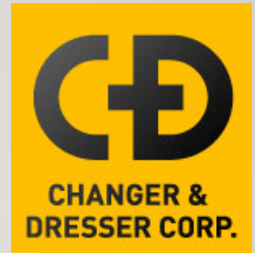

# KIKK-EL

Parts list		
No	Name	Model
1	KIKK-EL Body	KIKK-EL**
2	Upper magazine	STC-****U
3	Lower magazine	STC-****L
4	Component (Option)	CD-KIKKEL-KIT-STC-P

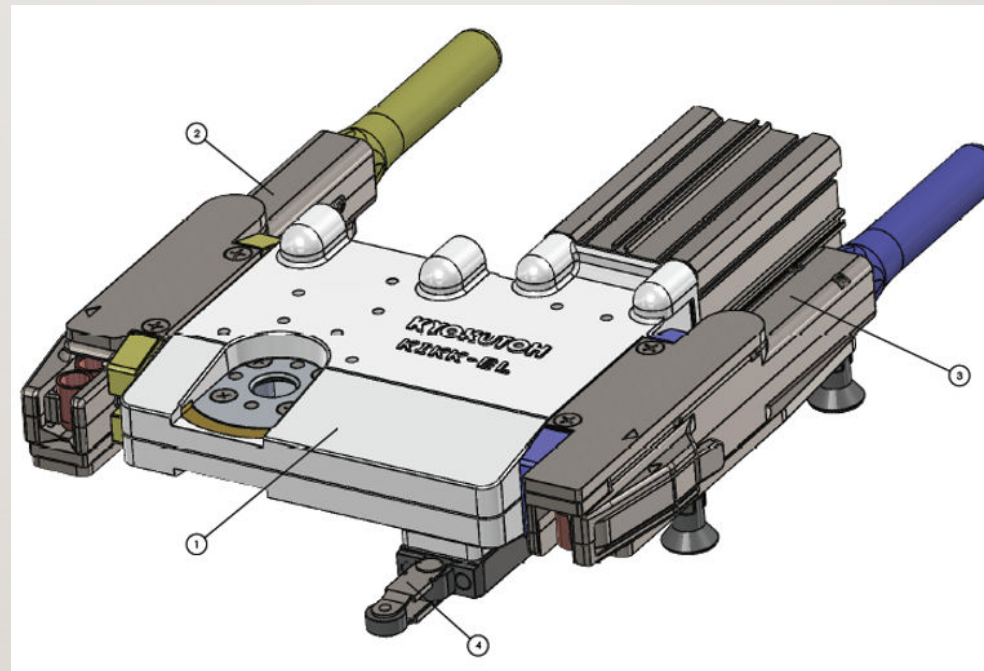

# KIKK Molded Kit Mechanical switch



<p><b>Cylinder Sensors</b></p>		<p>(1.0m Cable Length)</p> <p>#1 Engaged (FRONT closest to changer)</p> <p>#2 Not Engaged (BACK farthest from changer)</p>	<p><b>CYLINDER M8</b> BROWN = PIN 1 BLUE = PIN 3 BLACK = PIN 4</p>																							
<p><b>Magazine Sensors</b></p>		<p>(.3m Main/.5m S1/S2 Cable Length)</p> <p>#1 UPPER Cap Check</p> <p>#2 UPPER Mag Check</p> <p>#1 LOWER Cap Check</p> <p>#2 LOWER Mag Check</p>	<p><b>MAGIZINE M12</b> BROWN = PIN 1 BLUE = PIN 3 BLACK = PIN 4</p>																							
<p><b>Solenoid Valve</b></p>		<p>(.8m Cable Length)</p>	<p><b>Regular/ Filter</b></p>																							
<p><b>Limit Switch</b></p>		<p>(1.0m Cable Length)</p>	<p><b>Regular/ Filter</b></p>																							
	<p>Push in fittings are provided for valve and reg/filter. 10mm OD supply hose needed.</p> <p>PROPRIETARY AND CONFIDENTIAL</p> <p>THE INFORMATION CONTAINED IN THIS DRAWING IS THE SOLE PROPERTY OF CHANGER &amp; DRESSER CORP. ANY REPRODUCTION IN PART OR AS A WHOLE WITHOUT THE WRITTEN PERMISSION OF CHANGER &amp; DRESSER CORP. IS PROHIBITED.</p>	<p><b>DESIGN APPLICATION</b></p> <p>UPPER WELD FACE Ø -</p> <p>LOWER WELD FACE Ø -</p> <p>UPPER CAP Ø -</p> <p>LOWER CAP Ø -</p> <p>UPPER GUN ANGLE -</p> <p>LOWER GUN ANGLE -</p> <p>GUN TYPE (C or X) -</p> <p>GUN PRESSURE (kgf) -</p> <p>DO NOT SCALE DRAWING</p>	<p><b>DIMENSIONS ARE IN MILLIMETERS</b></p> <p>ANGULAR: MACH ± .002 ± 1.0</p> <p>ONE PLACE DECIMAL ± 0.1</p> <p>TWO PLACE DECIMAL ± 0.05</p> <p>THREE PLACE DECIMAL ± 0.025</p> <p>NOTES: ---</p>	<table border="1"> <tr> <th>NAME</th> <th>DATE</th> </tr> <tr> <td>DRW/YS</td> <td>08/20/08</td> </tr> <tr> <td>DES APPR.</td> <td></td> </tr> <tr> <td>ENG APPR.</td> <td></td> </tr> <tr> <td>MATERIAL</td> <td></td> </tr> <tr> <td>FINISH</td> <td></td> </tr> </table>	NAME	DATE	DRW/YS	08/20/08	DES APPR.		ENG APPR.		MATERIAL		FINISH		<p>TIP CHANGER MODEL: KIKKEL (MG)</p> <p>PART NO.: KIKK MOLDED KIT WIRING STC V2.0</p> <table border="1"> <tr> <th>SIZE</th> <th>REF. NO.</th> <th>REV.</th> </tr> <tr> <td>A</td> <td>-</td> <td>0</td> </tr> <tr> <td>1</td> <td>WEIGHT</td> <td>1.01</td> </tr> </table>	SIZE	REF. NO.	REV.	A	-	0	1	WEIGHT	1.01
NAME	DATE																									
DRW/YS	08/20/08																									
DES APPR.																										
ENG APPR.																										
MATERIAL																										
FINISH																										
SIZE	REF. NO.	REV.																								
A	-	0																								
1	WEIGHT	1.01																								

# Molded Kit STCV2.0 Prox Switch.

<p><b>Cylinder Sensors</b></p>		<p>(1.0m Cable Length)</p> <p>#1 Engaged (FRONT closest to changer)</p> <p>#2 Not Engaged (BACK farthest from changer)</p>	<p><b>CYLINDER M8</b> BROWN = PIN 1 BLUE = PIN 3 BLACK = PIN 4</p>	
<p><b>Magazine Sensors</b></p>		<p>(.3m Main/.5m S1/S2 Cable Length)</p> <p>#1 UPPER Cap Check</p> <p>#2 UPPER Mag Check</p> <p>#1 LOWER Cap Check</p> <p>#2 LOWER Mag Check</p>	<p><b>MAGIZINE M12</b> BROWN = PIN 1 BLUE = PIN 3 BLACK = PIN 4</p>	
<p><b>Solenoid Valve</b></p>		<p>(.8m Cable Length)</p>	<p><b>Regular/ Filter</b></p>	
<p><b>Prox Sensor</b></p>		<p>(1.0m Cable Length)</p>	<p><b>MAGIZINE M12</b> BROWN = PIN 1 BLUE = PIN 3 BLACK = PIN 4</p>	
	<p>Push in fittings are provided for valve and reg./filter. 10mm OD supply hose needed.</p> <p>PROPRIETARY AND CONFIDENTIAL</p> <p>THE INFORMATION CONTAINED IN THIS DRAWING IS THE SOLE PROPERTY OF CHANGER &amp; DRESSER CORP. ANY REPRODUCTION IN PART OR AS A WHOLE WITHOUT THE WRITTEN PERMISSION OF CHANGER &amp; DRESSER CORP. IS PROHIBITED.</p>	<p><b>DESIGN APPLICATION</b></p> <p>UPPER WELD FACE Ø - ANGULAR: MACH 8 BEND ± 1.0 LOWER WELD FACE Ø - ONE PLACE DECIMAL ± 0.1 UPPER CAP Ø - TWO PLACE DECIMAL ± 0.05 LOWER CAP Ø - THREE PLACE DECIMAL ± 0.008</p> <p>UPPER GUN ANGLE - LOWER GUN ANGLE - GUN TYPE (C M X) - GUN PRESSURE (kgf) -</p> <p>DO NOT SCALE DRAWING</p>	<p>NAME DATE</p> <p>DRAWN Jan 2016 08/24/16</p> <p>ENG APPR.</p> <p>ENG APPR.</p> <p>MATERIAL</p> <p>FINISH</p>	<p>TYP CHANGER MODEL</p> <p>KIKKEL (STC)</p> <p>PART NO.</p> <p>KIKK MOLDED KIT WIRING</p> <p>STC V2.0 (CD-KIKKEL-KIT-STCPX-P)</p> <p>SIZE REF. NO. REV. 0</p> <p>A CD-KIKKEL-KIT-STCPX-P</p> <p>WEIGHT 197</p>

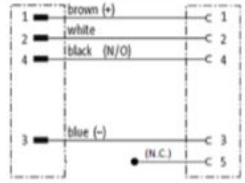
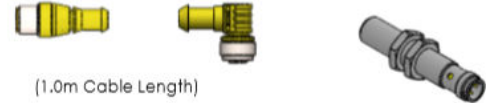

# DHSVR2 Molded Kit

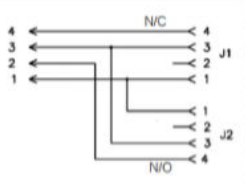
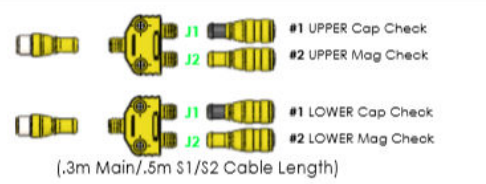
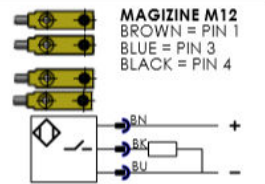
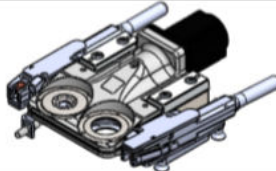
<p><b>Prox Sensor</b></p>  <p>M12</p>		 <p>(1.0m Cable Length)</p>	 <p><b>MAGINE M12</b> BROWN = PIN 1 BLUE = PIN 3 BLACK = PIN 4</p>																																																								
<p><b>Magazine Sensors</b></p>  <p>M12</p>		 <p>(.3m Main/.5m S1/S2 Cable Length)</p>	 <p><b>MAGINE M12</b> BROWN = PIN 1 BLUE = PIN 3 BLACK = PIN 4</p>																																																								
<div style="display: flex; justify-content: space-between;"> <div data-bbox="808 1036 1081 1205">  </div> <div data-bbox="1102 1036 1291 1205"> <p><b>Push in fittings are provided for valve and reg/filter. 10mm OD supply hose needed.</b></p> <p><b>PROPRIETARY AND CONFIDENTIAL</b></p> <p>THE INFORMATION CONTAINED IN THIS DRAWING IS THE SOLE PROPERTY OF CHANGER &amp; DRESSER CORP. ANY REPRODUCTION IN PART OR AS A WHOLE WITHOUT THE WRITTEN PERMISSION OF CHANGER &amp; DRESSER CORP. IS PROHIBITED.</p> </div> <div data-bbox="1302 1036 1732 1205"> <table border="1"> <thead> <tr> <th>DESIGN APPLICATION</th> <th>DIMENSIONS ARE IN MILLIMETERS</th> <th>NAME</th> <th>DATE</th> </tr> </thead> <tbody> <tr> <td>UPPER WELD FACE Ø</td> <td>ANGULAR: MAX ± .625 ± 1.0</td> <td>DRAWN</td> <td>05/04/15</td> </tr> <tr> <td>LOWER WELD FACE Ø</td> <td>ONE PLACE DECIMAL ± 0.1</td> <td>ENG APPR.</td> <td></td> </tr> <tr> <td>UPPER CAP Ø</td> <td>TWO PLACE DECIMAL ± 0.05</td> <td>ENG APPR.</td> <td></td> </tr> <tr> <td>LOWER CAP Ø</td> <td>THREE PLACE DECIMAL ± 0.005</td> <td>MATERIAL</td> <td></td> </tr> <tr> <td>UPPER GUN ANGLE</td> <td>NOTES ---</td> <td>FINISH</td> <td></td> </tr> <tr> <td>LOWER GUN ANGLE</td> <td></td> <td></td> <td></td> </tr> <tr> <td>GUN TYPE (C or X)</td> <td></td> <td></td> <td></td> </tr> <tr> <td>GUN PRESSURE (kg)</td> <td></td> <td></td> <td></td> </tr> <tr> <td>DO NOT SCALE DRAWING</td> <td></td> <td></td> <td></td> </tr> </tbody> </table> </div> <div data-bbox="1743 1036 2016 1205"> <table border="1"> <thead> <tr> <th colspan="2">TIP CHANGER MODEL</th> </tr> </thead> <tbody> <tr> <td colspan="2">KIKKEL (STC)</td> </tr> <tr> <th colspan="2">PART NO.</th> </tr> <tr> <td colspan="2">DHSVR2 MOLDED KIT WIRING STC V2.0 (CD-DHSVR2-KIT-STCPX-P)</td> </tr> <tr> <th>SIZE</th> <th>REF. ID</th> </tr> <tr> <td>A</td> <td>CD-KIKKEL-KIT-STCPX-P</td> </tr> <tr> <th>REV.</th> <th></th> </tr> <tr> <td>0</td> <td></td> </tr> </tbody> </table> </div> </div>				DESIGN APPLICATION	DIMENSIONS ARE IN MILLIMETERS	NAME	DATE	UPPER WELD FACE Ø	ANGULAR: MAX ± .625 ± 1.0	DRAWN	05/04/15	LOWER WELD FACE Ø	ONE PLACE DECIMAL ± 0.1	ENG APPR.		UPPER CAP Ø	TWO PLACE DECIMAL ± 0.05	ENG APPR.		LOWER CAP Ø	THREE PLACE DECIMAL ± 0.005	MATERIAL		UPPER GUN ANGLE	NOTES ---	FINISH		LOWER GUN ANGLE				GUN TYPE (C or X)				GUN PRESSURE (kg)				DO NOT SCALE DRAWING				TIP CHANGER MODEL		KIKKEL (STC)		PART NO.		DHSVR2 MOLDED KIT WIRING STC V2.0 (CD-DHSVR2-KIT-STCPX-P)		SIZE	REF. ID	A	CD-KIKKEL-KIT-STCPX-P	REV.		0	
DESIGN APPLICATION	DIMENSIONS ARE IN MILLIMETERS	NAME	DATE																																																								
UPPER WELD FACE Ø	ANGULAR: MAX ± .625 ± 1.0	DRAWN	05/04/15																																																								
LOWER WELD FACE Ø	ONE PLACE DECIMAL ± 0.1	ENG APPR.																																																									
UPPER CAP Ø	TWO PLACE DECIMAL ± 0.05	ENG APPR.																																																									
LOWER CAP Ø	THREE PLACE DECIMAL ± 0.005	MATERIAL																																																									
UPPER GUN ANGLE	NOTES ---	FINISH																																																									
LOWER GUN ANGLE																																																											
GUN TYPE (C or X)																																																											
GUN PRESSURE (kg)																																																											
DO NOT SCALE DRAWING																																																											
TIP CHANGER MODEL																																																											
KIKKEL (STC)																																																											
PART NO.																																																											
DHSVR2 MOLDED KIT WIRING STC V2.0 (CD-DHSVR2-KIT-STCPX-P)																																																											
SIZE	REF. ID																																																										
A	CD-KIKKEL-KIT-STCPX-P																																																										
REV.																																																											
0																																																											

# DHSVR2 LENZ Switch

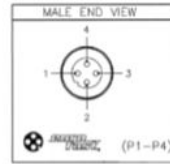

M12 Male

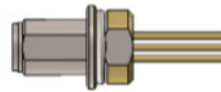

**Control Box SIGNALS**

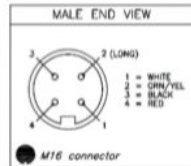
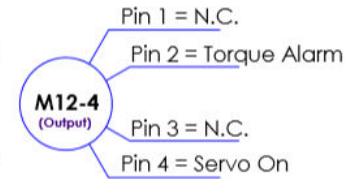
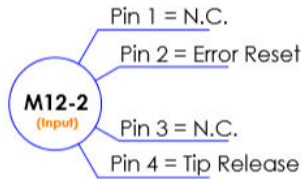
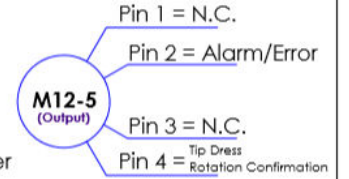
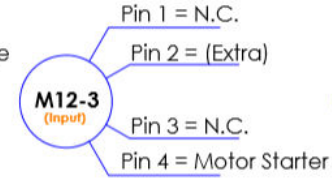
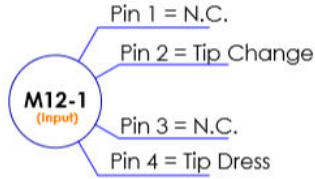

M16 Male



**480VAC**

Pin 4 = L3  
Pin 3 = L2  
Pin 2 = GND  
Pin 1 = L1

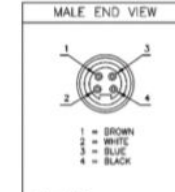

7/8 Male



**24VDC**

Pin 4 = 0VDC  
Pin 1 = +24VDC

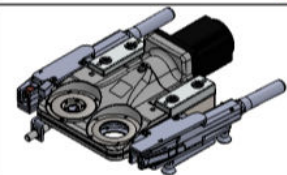

**PROPRIETARY AND CONFIDENTIAL**  
THE INFORMATION CONTAINED IN THIS DRAWING IS THE SOLE PROPERTY OF CHANGER & DRESSER CORP. ANY REPRODUCTION IN PART OR AS A WHOLE WITHOUT THE WRITTEN PERMISSION OF CHANGER & DRESSER CORP. IS PROHIBITED.

DESIGN APPLICATION	DIMENSIONS ARE IN MILLIMETERS
UPPER WELD FACE @	ANGULAR, MAX & MIN ± 1.0
LOWER WELD FACE @	ONE PLACE DECIMAL ± 0.1
UPPER CAP @	TWO PLACE DECIMAL ± 0.05
LOWER CAP @	THREE PLACE DECIMAL ± 0.005
UPPER GUN ANGLE	NOTES: ---
LOWER GUN ANGLE	
GUN TYPE (C # X)	
GUN PRESSURE (MP)	
DO NOT SCALE DRAWING	

NAME	DATE
DRAWN: JAH/JPM	04/28/18
MFG APPR:	
ENG APPR:	
MATERIAL:	
FINISH:	

Changer & Dresser Corp.  
A DIVISION OF  
KYOKUTOH CO., LTD

TIP CHANGER MODEL	PART NO.	REV.
DHSVR2	DHSVR2 Lenze Control Pinout	0
SIZE A	WEIGHT	REV. 0
11		1 of 1



Changer & Dresser KIKK Tip Changer.			
QTY	PART #	DESCRIPTION	MANUF
1	FA3-C3PA	3/8" Filter/Regulator Combination Unit	Fabco Air
1	MME-43WES-D024	3/8" NPT In/Out, 1/4" NPT exhaust, 5/2 valve w/ Cable Gland	Clippard
1	7000-40981-6560150	Form BI (11 mm) – M12, male straight valve connector, black, weld spatter resistant	Murr
1	FD 531-K50	Mechanical limit switch, 1 N.O. contact + 1N.C., roller arm activation, 5-pin M12 connector	Pizzato
1	WK 4.5T-I-RS 4.5T/S1587	M12 90-Female 5-Pin to M12 STM 5-Pin Cordset (1m)	Murr
2	Bi 6-EGT12FE-AP6X-H1141	Inductive Prox, M12 Connector, PNP, DC, NO, 12mm x 6mm SN	TURCK
2	RKC 4.4T-I-RSC 4.4T/S3060	M12 STM/STF 4-Pin Cordset (1m)	TURCK
1	10 425 1038	10mm PIF x 3/8" NPT straight male fitting	Norgren
4	10 147 1038	10mm PIF x 3/8" ISO R 90 degree swivel male fitting	Norgren
1	VB2-FSM4.4/2PKG3M-1/1	T-Coupler, M12 4 x 2xM8 3	TURCK
1	VB2-FSM4.4/2FKM4	T-Coupler, M12 4 x 2xM12 4	TURCK
2	MZCK 03PI011/KS35D	Magnetic cylinder sensors, M8 Connector, PNP (300mm) (Can't change, come w/cylinder)	Baumer
1	FXEN-IOM88-0001-IP/CS30007	8 Input/8 IUTOYT-Ethernet AIM Station	TURCK

